

HH#:1-512

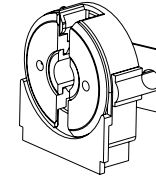
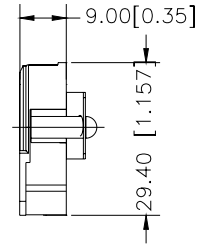
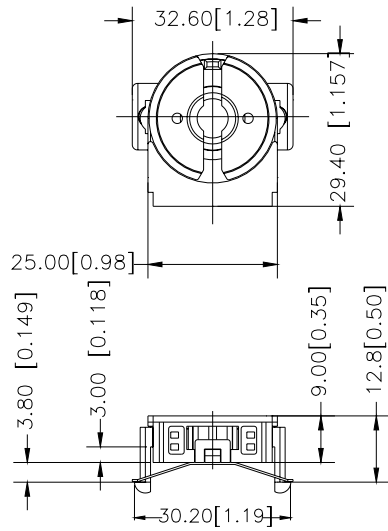

H.H. FLUORESCENT PARTS.INC.			UNLESS OTHERWISE SPECIFIED: DIMENSIONS ARE IN MM TOLERANCES	
MODEL	SCALE	UNIT	DECIMALS	ANGULAR
	1??1	MM	.XX ±.05	± 0.5°
TITLE	MATERIAL	SHEET	.XXX ±.010	
		A4	DRAWN	DATE
		REV	HYF	09.1.16
DRAW NO.	PAPER NO.		DESIGN	
			APPROVED	